

Ages 10 to adult

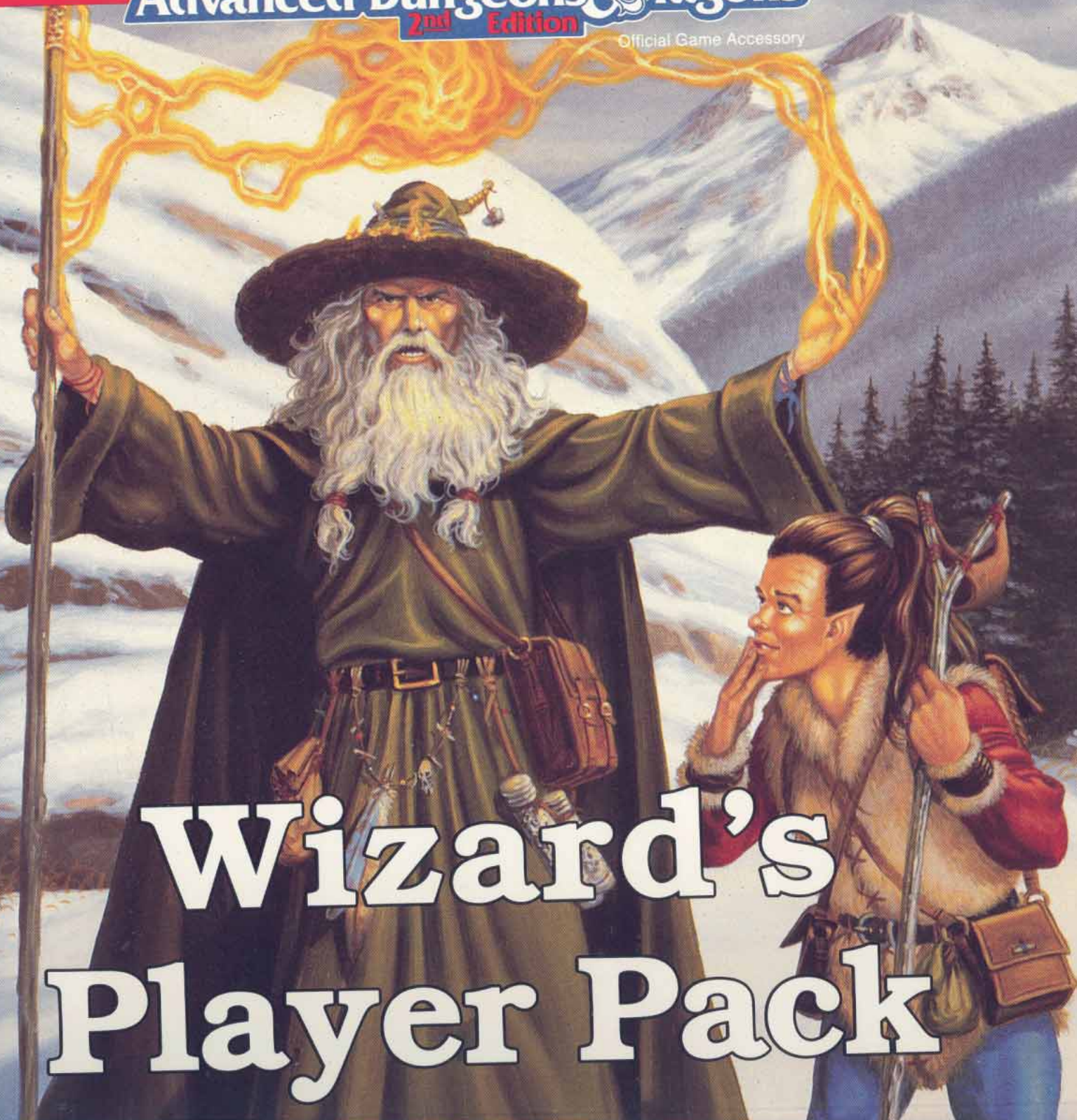

Wizard's Player Pack



The BEGINNER'S GUIDE to the



Wizard



Advanced Dungeons & Dragons[®]

2nd Edition Game Accessory

The Beginner's Guide to the Wizard

Design: William W. Connors
Editing: John D. Rateliff
Coordination: Bruce Nesmith
Interior Art: Terry Dykstra
Photography: Charles Kohl
Models: Dennis Kauth
Production: Nancy J. Kerkstra

This material is protected under the copyright laws of the United States of America. Any unauthorized use of the material or artwork contained herein is expressly prohibited without the written consent of TSR, Inc. Copyright ©1994 TSR, Inc. All Rights Reserved. Printed in the U.S.A.

Random House and its affiliate companies have worldwide distribution rights in the book trade for English language products of TSR, Inc. Distributed to the book and hobby trade in the United Kingdom by TSR Ltd. Distributed to the toy and hobby trade by regional distributors.

ADVANCED DUNGEONS & DRAGONS and AD&D are registered trademarks owned by TSR, Inc.

The TSR logo is a trademark owned by TSR, Inc.

All TSR characters, character names, and the distinctive likenesses thereof are trademarks owned by TSR, Inc.

TSR, Inc.
PO Box 756
Lake Geneva
WI 53147
U.S.A.

1113XXX1901



TSR Ltd.
120 Church End
Cherry Hinton
Cambridge CB1 3LB
United Kingdom

ISBN 0-7869-0040-7

The Shaping of a Wizard

The thing that makes the ADVANCED DUNGEONS & DRAGONS® game more than just a historical re-creation of life in the Middle Ages is, of course, magic. Without magic there would be no dragons to slay, no terrible legions of undead to battle, and no enchanted kingdoms to defend. Truly, the wonder of any AD&D® campaign setting is the inclusion of the supernatural.

There is no class that invokes visions of mighty spells and mystical powers more clearly than the wizard. Wizards are familiar to anyone who has ever read a fantasy novel, seen a fantasy film, or played a fantasy game. Beginning players often model their wizards on characters from literature like Gandalf and Merlin.

While this can be great fun, not every wizard is an old man with a long beard and a pointed hat. Once a player is comfortable with the AD&D magic system and game rules, he or she may enjoy creating a wizard character that is somewhat out of the ordinary. This can be done with specific ability scores, the selection of unusual proficiencies, or even just the establishment of an unusual background for the character. For the moment, we'll concentrate on mages and save discussion of specialist wizards for later on in this booklet.

Ability Scores: The one ability all wizards have in common is a high Intelligence. Where a player can begin to individualize his or her character is in the way that the other ability scores are assigned.

For example, just because most wizards have poor scores in Strength and Constitution does not mean that *all* do; a mage able to bend bars as well as a typical fighter would certainly lift eyebrows. Similarly, a sorceress with a superior Constitution might enjoy perfect health



and be able to sustain a pace that leaves other party members begging for a rest. A high Dexterity gives a wizard bonuses to attacks with missile weapons as well as an Armor Class bonus that can be a real life-saver. A wizard with high scores in all three of these abilities will be highly competent in a toe-to-toe fight, often to the surprise of friend and foe alike.

Wisdom has less direct game application for a wizard, but a high score here to compliment his or her Intelligence will produce a character who is not just clever but thoughtful

and might well be a philosopher. Finally, a high Charisma is essential if a wizard hopes to assemble a large group of reliable henchmen.

Proficiencies: For the wizard, magic is not just something he or she does; it is a defining part of the character's life. Even so, he or she will have other interests that help determine what type of spellcasting he or she is good at. The diversity of proficiencies available in the AD&D game system makes it easy to customize a character. For example, a young aristocrat who learned her craft from her royal uncle's court wizard might have the etiquette, dancing, heraldry, and reading/writing proficiencies to reflect her noble background. By contrast, a wizard who lives in the forest and prefers the company of animals to people might have animal handling, herbalism, and weather sense.

A player willing to spend the extra proficiency slots to purchase skills outside of his or her character's area of expertise can do even more to create a unique character. For example, a street-smart wizard who picked up the art of wizardry while trying to survive as a homeless street urchin might have a few rogue proficiencies, like ventriloquism or reading lips. With a little imagination, the possibilities are endless.

Masters of the Supernatural

Many AD&D game players portray their wizard characters as nothing more than members of some supernatural S.W.A.T. team. If the monster attacking the party is too powerful for the fighter, can't be turned by the priest, and avoids being backstabbed by the thief, everyone turns to the wizard. With a tip of his or her pointy hat, the wizard mumbles a few mystical words and (**KA-BOOM!**) fries the beast with a *fireball* or *lightning bolt* spell.

Players running wizards should recognize that their characters are magical beings, just like dragons or any number of other spell-casting entities. As such, they want more out of adventuring than the combat that attracts fighters or the treasure that beckons to thieves.

Getting Ready to Adventure: In most cases, a wizard must select his or her spells before knowing exactly what sort of challenges he or she will be confronted with the following day. A player who opts to have his or her character memorize only combat spells will be at a loss when confronted with an area that has been laced with traps. Conversely, a wizard who does not make any preparations for battle may be unable to save his or her party from destruction.

Knowing which spells to select is never easy. There will always be a time in every adventure when the player running a wizard thinks *why didn't I have my character memorize a comprehend languages instead of that stupid Tenser's floating disc spell?* Still, there are many clues that can help a player choose his or her character's spells wisely, and a creative player can always find unexpected and innovative ways to use them.

If the player has any information at all about the type of monsters the party is likely to face, this can dictate the selection of spells. For example, if a wizard and her companions



are going to explore a vampire's keep, it's a good bet that spells like *detect undead* or *hold undead* will be of use. By the same token, spells such as *charm* or *sleep* will probably be of less use, as most undead creatures are immune to them.

During an Adventure: As play commences, the wizard must be careful to use memorized spells with care. After all, his or her magic is a limited resource. The wizard cannot be certain that he or she will be able to rest and recover spells. Even if the pace of an adventure seems to allow for

it, random encounters might well disrupt his or her concentration. Of course, spells like *wyvern watch* can be used to make the party's campsite safer, but memorizing such a spell reduces the number of combat or defensive enchantments available.

As the party members move through the adventure, they will be confronted with countless challenges. A good DM will see to it that his or her players must face any manner of different obstacles. Some will require combat, others quick thinking, and still others nimble fingers. Almost without a doubt, however, there will be those encounters that demand magic to resolve—whether a *wizard locked door* in need of a good *knock* or a monster that can only be harmed by magic.

Wrapping Things Up: Once a party has completed its mission, there will no doubt be treasures to examine. For this, there is no spell more useful than a simple *detect magic*. When used in conjunction with other divinational magics, like *identify*, it enables the wizard to become a most useful source of information.

Without the services of such a character, most parties will be unable to ascertain for certain whether items are mundane or magical, cursed or beneficial.

The Secret Orders of Magic

Most wizards seek to amass a wealth of knowledge about any form of magic they encounter. Occasionally, however, a wizard devotes himself or herself to the absolute mastery of a specific school of magic. In this section, we'll take a brief look at each of these specialist wizard types and at the way in which they are most commonly role-played.

Abjurers: These specialist wizards focus on defensive spells and are reluctant to use their magic for attacks. They tend to be quiet and soft-spoken and spend much of their time in meditation and contemplation.

Transmuters: In more technological societies, these characters would probably have become scientists or inventors, as they are expert at the art of changing one thing into another. Their school has more spells than any other, giving them the greatest flexibility of any specialist. Transmuters love to use their magic, varying their spell choice each day. They rarely let a day end with any of their memorized spells uncast.

Conjurers: These specialists prefer to let others do their dirty work and are apt to summon up a monster to do their fighting for them. This reliance upon minions completely under their control creates a tendency among some conjurers to be rather bossy and give orders to their companions as if they were conjured servants. Naturally, this type of behavior has given the whole school a bad name that it does not altogether deserve.

Enchanters: These charismatic wizards have a knack for getting along with people. Like conjurers they are expert at getting other people to do things for them, but enchanters use their charm, winning personality, and knowledge of other people's motivations to achieve their goals.



Diviners: In a sense, these characters are the detectives and sages of the wizard class. Insatiably curious, they join adventuring parties mainly in order to seek out otherwise unobtainable information or lore. Between investigations they prefer to be left to themselves to ponder over the results of their latest inquiry.

Illusionists: This, the best known school of specialist wizards, attracts characters who are both nimble and quick-witted. A fascination with appearances and a deep knowledge of how to manipu-

late and deceive people enable the illusionist to give others the impression that he or she is more powerful than the character actually is—which is exactly the way the illusionist wants it. Illusionists do not get on well with diviners, who consider their phantasms mere deception and trickery, but others appreciate their cleverness and flair with which they apply their spells.

Invokers: These wizards are intense and determined, desiring nothing more than to master their chosen art. They are among the most aggressive and confident of all wizards. They do not fear battle, looking upon it as a chance to unleash their awesome powers upon an unsuspecting enemy. Many of the most famous wizard spells, like *magic missile* and *fireball*, belong to this school.

Necromancers: These masters of death are obsessed with the ultimate dichotomy of life and death, leaving them little time for social niceties. The average necromancer is calm, dispassionate, humorless, and anything but squeamish. To them, a dead body is simply a material component, and they tend to forget how gruesome their work appears to others. Necromancers are quite unpopular in most societies, but their ability to create and control undead makes them very powerful.

The Character Record Sheet

Included with the *Wizard's Player Pack* is a tablet of 12 character record sheets (often just called character sheets). These provide a simple way for players to keep track of the important information that defines their characters. TSR grants permission to photocopy these sheets for personal use.

These sheets are designed to be easy to use. All of the information on the sheet is grouped into the following blocks for easy reference.

1. Personal Information: In this area the player can record the name he or she makes up for the character, as well as information about the character's race, class, level, and alignment. Additional spaces permit the player to record a general description of his or her character.

2. Ability Scores: This is probably the first area of the character sheet that the player will fill out when creating a new character. It includes spaces for keeping track of a character's ability scores and all of the game modifiers generated by them.

3. Hit Point Record: This portion of the character record sheet is placed where it will be easy to see and use at all times. A character's current hit point total is likely to change frequently during combat, so players should write lightly when recording information on wounds their characters receive.

4. Attack Table: This part of the character record sheet will probably be referenced more often than any other. There is a space to record the character's THACO listing as well as the melee and missile attack modifiers determined by the character's Strength and Dexterity scores.

Once these three boxes at the top are filled in, the player can quickly fill out the table of rolls required to hit various Armor Classes from 10 to -10. It is recommended that no modifiers be

The image shows a sample of the Character Record Sheet form. It is divided into several sections, each with a numbered callout:

- 1:** Personal Information (Name, Race, Class, Level, Alignment, etc.)
- 2:** Ability Scores (Strength, Dexterity, Constitution, Intelligence, Wisdom, Charisma)
- 3:** Hit Points (Current, Maximum)
- 4:** Attack Table (THACO, Melee, Missile)
- 5:** Weaponry Information (Weapon, Damage, etc.)
- 6:** Armor Class (Surprised, Attacked from behind, etc.)
- 7:** Character Sketch (A box for drawing or a portrait sticker)
- 8:** Experience Points (Current, Next level, etc.)
- 9:** Saving Throws (Fire, Acid, Cold, Electricity, Poison, etc.)

applied before recording the numbers in this column; instead, players should write in the basic roll needed to hit a target of the Armor Class listed.

5. Weaponry Information: In this space the player can record all the specifics on the character's favorite weapon(s), along with the attack penalty the wizard suffers when using any weapon with which he or she is not skilled. The information is grouped by general notes, attack data, and damage specifications for each weapon.

6. Armor Class Information: In this block the player can record his or her character's Armor Class. Since wizards do not wear armor, they tend to have poor Armor Classes, but Dexterity bonuses and magical protection can offset this somewhat. Space is provided to record the Armor Class the character has when surprised or attacked from behind, as well as AC modifiers due to magical items.

7. Character Sketch: Artistic players will want to draw a sketch of their character in this box. Others can select one of the portrait stickers included in this kit (or some other piece of artwork) and secure it here to help them visualize their character.

8. Experience Point Record: This space can be used to record the number of experience points (XPs) that the character has accumulated, along with the total needed to advance to the next level. The player can also note here whether his or her character is entitled to the 10% bonus in XPs awarded to characters with exceptional scores in the prime requisite of their chosen class.

9. Saving Throw Table: In this space the player can record all of the saving throws appropriate to the character due to his or her class and level.

The Character Record Sheet

10. Spellbook: This block provides a place for the player to write down all the spells his or her wizard character knows. Two columns of smaller boxes make it easy for the player to check off which spells the character has memorized for that gaming session and which of those he or she has cast.

11. Racial Abilities: Any special abilities a character has due to his or her race (such as infravision or silent movement) can be recorded here.

12. Weapon Proficiencies: Players in campaigns that use the optional weapon proficiencies rules should write down those weapons with which their character is skilled. Space is also provided to record the number of slots the character begins the campaign with, as well as the rate at which he or she accrues additional slots. The penalty for using a weapon with which the character is not proficient can be recorded here as well.

13. Nonweapon Proficiencies: Like Block 12, this area is intended for use by those campaigns employing the optional proficiency rules. The number of slots that a character begins with, the number of bonus slots he or she receives for high Intelligence (see the **add'l languages** box in Block 2), and the rate at which he or she acquires new slots can be recorded at the top of the box. The name of each skill selected by a player, the number of slots allocated to it, its relevant ability score, and any needed modifiers to proficiency checks can be recorded on the lines below.

14. Equipment Carried: This block can be used to record all of the equipment that a character takes along on an adventure, as well as the cost and weight of each item. A space at the bottom of the block allows the player to total the value and weight of the items he or

she is carrying. The former is mainly for record keeping purposes, while the latter is used in conjunction with the rules on movement and encumbrance (Blocks 16 and 17).

15. Wealth: As a character adventures, he or she will gradually accumulate a great deal of wealth. This block allows a player to record the extent of his or her character's treasure. Separate columns are provided to list each different type of coin (cp, sp, gp, &c.), how much coinage is carried by the character when he or she goes on an adventure, and how much

he or she has hidden away in caches. A box at the bottom of the block provides space for the recording of unusual valuable items like gemstones or pieces of jewelry.

16. Encumbrance: For players in campaigns using the optional encumbrance rules, this space records the carrying capacity of a character (as indicated by his or her Strength score). In addition, notes remind the player of the negative effects that encumbrance will have on the character's combat abilities.

17. Movement: This block contains an easy-to-use table that the player can quickly fill out for reference during play. First, the base movement rate for the character (12 for humans, elves, and half-elves; 6 for dwarves, halflings, and gnomes) is recorded in the heavier block. The first column, which reflects the movement rate of a walking character at the various levels of encumbrance, can then be calculated quickly. Once this is done, the player can determine the rates of movement when his or her character is jogging or running by simply multiplying row by row. Thus, for humans the numbers in the first column will be 12, 8, 6, 4, and 1, while the numbers in the top row will be 12, 24, 36, 48, and 60.

The Mapping Tablet

One of the most useful things included with the Player Pack is a pad of mapping paper. A close look at this tablet will reveal that there are actually **four** types of paper in it. Each of these has a special use and allows the player to keep careful track of his or her character's various adventures. Care has been taken to make the papers in this tablet useful to both players and Dungeon Masters. In addition, TSR grants permission for AD&D game players to photocopy these sheets for personal use, so you'll never run out of them. Just make sure that you don't use your last original, or you won't have a good master left to copy.

A quick look at these sheets will reveal that the grids on them are not composed of solid lines. Rather, a pattern of crosses (or triads for the hex grids) is used. This is because a map drawn on a standard sheet of graph or hex paper is difficult to reproduce on a photocopier; the solid lines printed on the paper tend to make the hand-drawn map difficult to read. By contrast, photocopies of maps made on these sheets should be just as readable as the original.

- **Regional Maps (½-inch hexes):** The regional map sheet is covered with a hexagonal grid. These sheets should be used for mapping large geographical areas, like a country. It can be used by players to map unexplored territory as their characters move through it or to lay out a plan of the grounds surrounding a player character's castle. The scales used on these maps will vary with the size of the territory being mapped.
- **Strategic Maps (¼-inch squares):** The next type of paper in the mapping tablet is a simple square grid. It is intended for use in creating a strategic map of a large structure,

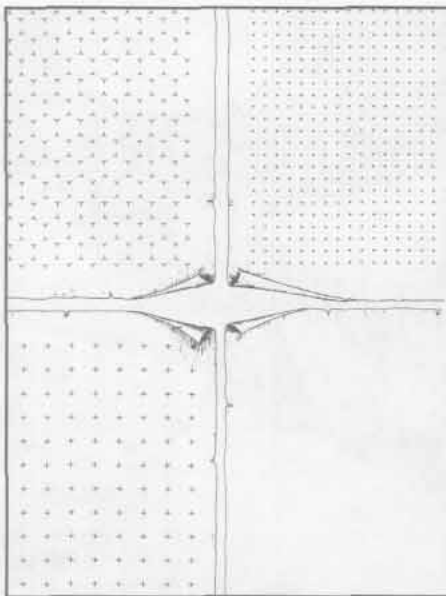

such as the dungeon complex beneath a castle. Once a hexagonal regional map has been made of an area, the buildings on (or under) it can be mapped with this type of paper. This is the type of paper that players will generally use when mapping the dungeons their characters are exploring. In addition, when a character designs and builds a castle, temple, tower, or other large structure, the player can map it with these sheets.

- **Tactical Maps (½-inch squares):**

This paper is intended for use in making maps of smaller areas, usually a close-up shot of some area on a strategic map. Players can use it to make more detailed maps of unusual rooms (tombs, shrines, and the like) that their characters encounter while exploring the dungeons recorded on the strategic maps. Once a player has mapped his or her character's stronghold, he or she can detail the most important areas of it on a tactical map.

The larger size of this grid makes it easy to use with metal miniatures as well. Players who decide to become Dungeon Masters will find these sheets useful for making maps of the rooms in a dungeon where combat is likely to take place. When the characters reach that area, just pull out the map of the area, place it on the table, and let the battle begin!

- **Parchment Blanks:** The last type of paper included in the kit is simply a blank sheet with a border on it that looks like curling parchment. This is intended primarily for those wishing to make props for use during game play. Players and Dungeon Masters can use this to create wanted posters, public notices recruiting followers, crude treasure maps, and similar documents.

Painting Guide

Many gamers find that their role-playing sessions are greatly enhanced by the use of miniature figures. While it is true that a whole book could be written on the many techniques involved in painting figures, the basics can be explained fairly briefly. Remember, though: the best way to become a skilled miniatures painter is to practice.

1. Cleaning: Even the best miniatures will need to be cleaned before they are ready to paint. Start by trimming away any excess metal and carefully filing away obvious seams, especially on the underside of the figure's base. After that is done, the figure should stand steadily on its own.

Once the miniature has been trimmed and smoothed, wash it in warm, soapy water to remove any dirt, grease, or oil. Set the figure out to dry, preferably overnight. After you have cleaned your figures, try to handle them as little as possible.

2. Mounting: It is always best to secure a figure to a base. For human-sized figures, it is customary to use a ½-inch square of poster board. In most cases, epoxy or super-strength glues work best. Of course, always use fast-bonding adhesives with care.

3. Priming: It is best to apply an undercoat, or primer, to your miniatures before painting them. The best all-around primer for miniatures is light gray in color and applied with a spray can. It is best to use a few thin coats of primer rather than a single thicker layer. After you prime your figures, let them dry overnight.

4. Base Colors: After your primed figures are fully dried, it is time to start painting them. It is usually best to start by painting the areas that



are hardest to get at. Another important thing to paint early on are areas of exposed flesh.

For more realistic figures, paint in the shadows in folds of clothing first, using a darker shade that complements the color you have chosen. After that dries, paint the rest of the item with the main color. Now, your figure will have lifelike folds and shadows.

5. Highlighting: When all of your base colors have dried, you can move on to highlighting. Start with a lighter color than the area you plan to highlight. For example, if you were doing the highlights on a gray cloak, you could use a light gray or maybe even white. After you put the paint on your brush, dab it off with a piece of paper. Be careful not to crush the bristles, but make sure that there is no visible liquid left on the brush. Once that is done, lightly brush the color onto the area you want to highlight.

If you do it right, highlighting will leave you with light traces of paint on the raised areas of the figure.

6. Detailing: After all of your highlights are dry, go back and paint the little details. Now is the time to get the buttons on jackets, rivets on shields, and the like. When all is said and done, the highlights can make an otherwise average figure look outstanding!

7. Protection: When you are done painting your miniature, set it aside and let it dry overnight. Then apply a clear acrylic spray to your miniature to protect it from nicks, scratches, and dirt. Acrylic sealers come in both matte (dull) or gloss (shiny) finishes. Most people use a matte finish to make their figure look as realistic as possible. Use several thin coats of acrylic rather than one heavy one.



**Male
Wizard**



Illusionist

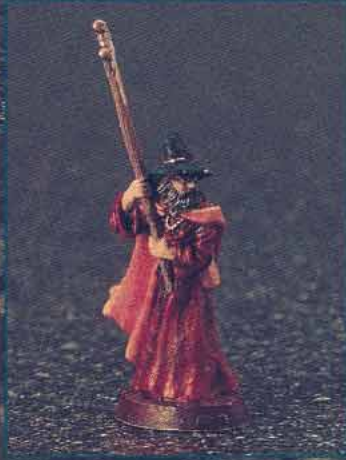

**Female
Wizard**



Character Name		Class (Kit)	
Alignment	Race	Experience Level	
Age & Sex	Height & Weight	Hair & Eyes	

Distinguishing Features

Strength		Melee Attack	Melee Damage	Weight Allowance	Max. Press	Open Doors	Bend /Lift
Dexterity		Surprise Adjust.	Missile Attack	Defensive Adjust.			
Constitution		Hit Point Adjust.	System Shock	Ressurrect Survival	Poison Save	Regen. Rate	
Intelligence		Add'l. Languages	Max. Spell Level	% Learn Spells	Max. No. /Level	Spell Immunity	
Wisdom		Magical Defense	Bonus Spells		% Spell Failure	Spell Immunity	
Charisma		Max. No. Henchmen	Loyalty Adjust.	Reaction Adjust.			

Hit Points

Wounds Suffered

Attack Table

Melee Attack	THAC0	Missile Attack
-1		1
-2		2
-3		3
-4		4
-5		5
-6		6
-7		7
-8		8
-9		9
-10		10

Roll number or higher on 1d20

Weaponry Information

Nonproficiency Penalty

Weapon Type	Type	Speed	# Attacks	Attack Adjust.	Ranges (S/M/L)	Damage Adjust.	Damage vs. S/M	Damage vs. L

Armor Class

Armor Worn

Base AC	Surprised AC
Shieldless AC	Rear AC

Other Defenses

Character Sketch

Experience Points

+10% XP Bonus? Yes No

Next Level XP Goal

Saving Throws

Paralysis, Poison, or Death	Rod, Staff, or Wand	Petrification or Polymorph	Breath Weapon	Magical Spell
<input type="text"/>	<input type="text"/>	<input type="text"/>	<input type="text"/>	<input type="text"/>

Wizard Abilities

Spells per Level

1	2	3
4	5	6
7	8	9

Primary School

Opposition Schools

Memorized Cast

<input type="checkbox"/>	<input type="checkbox"/>
<input type="checkbox"/>	<input type="checkbox"/>
<input type="checkbox"/>	<input type="checkbox"/>
<input type="checkbox"/>	<input type="checkbox"/>
<input type="checkbox"/>	<input type="checkbox"/>
<input type="checkbox"/>	<input type="checkbox"/>
<input type="checkbox"/>	<input type="checkbox"/>
<input type="checkbox"/>	<input type="checkbox"/>
<input type="checkbox"/>	<input type="checkbox"/>
<input type="checkbox"/>	<input type="checkbox"/>
<input type="checkbox"/>	<input type="checkbox"/>
<input type="checkbox"/>	<input type="checkbox"/>

Spell Book

Weapon Proficiencies

Initial Slots

Add'l Slot/lvs

Nonprof. Penalty

Weapon Name

Nonweapon Proficiencies

Initial Slots

INT Bonus

Add'l Slot/lvs

Proficiency Name

Rel. Check
Slots Able Mod.

Proficiency Name	# Slots	Rel. Able	Check Mod.

Roll number or less on 1d20 to succeed

Equipment

Item Carried Cost Wt.

Item Carried	Cost	Wt.
Totals	<input style="width: 50px; height: 20px;" type="text"/>	<input style="width: 50px; height: 20px;" type="text"/>

Racial Abilities

Wealth

Type (GP Value) Carried Cached

Type (GP Value)	Carried	Cached

Treasures (Gems, Jewelry, etc.)

Encumbrance

Category	Weight	Combat Effects
None	<input style="width: 40px; height: 20px;" type="text"/>	None
Light	<input style="width: 40px; height: 20px;" type="text"/>	None
Moderate	<input style="width: 40px; height: 20px;" type="text"/>	-1 Attack
Heavy	<input style="width: 40px; height: 20px;" type="text"/>	-2 Attack, +1 AC
Severe	<input style="width: 40px; height: 20px;" type="text"/>	-4 Attack, +3 AC
Maximum	<input style="width: 40px; height: 20px;" type="text"/>	-4 Attack, +3 AC

Move Rates

Move Rate	Walk (x1)	Jog (x2)	Run (x3)	Run (x4)	Run (x5)
None (Base Move)	<input style="width: 40px; height: 20px;" type="text"/>				
Light (2/3 Move)					
Moderate (1/2 Move)					
Heavy (1/3 Move)					
Severe or Max. (Move=1)					

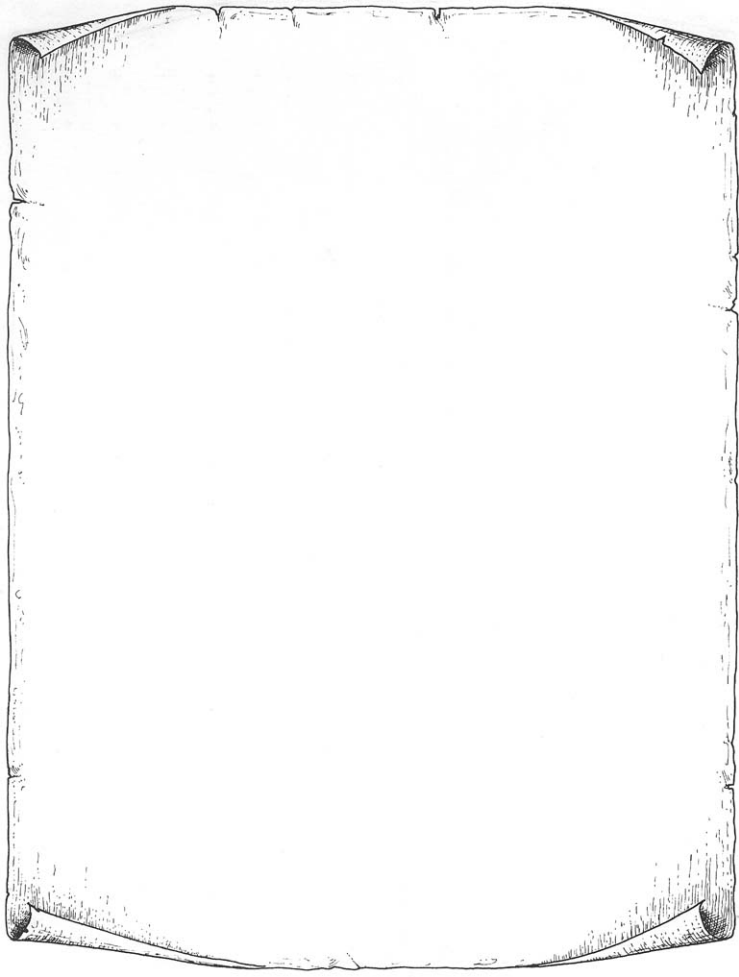

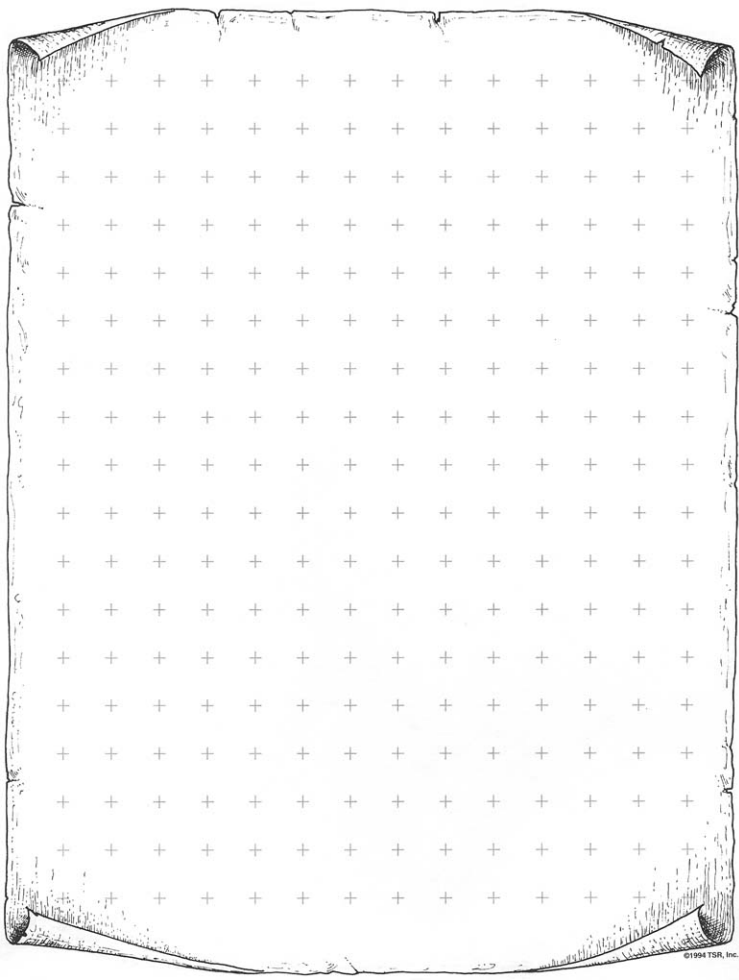

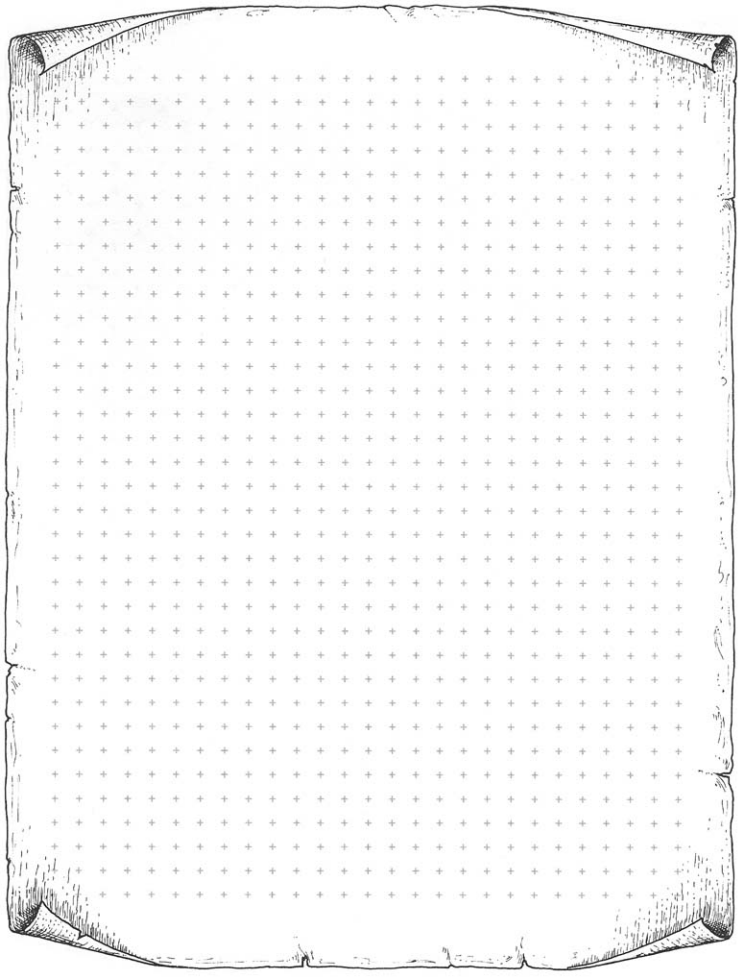

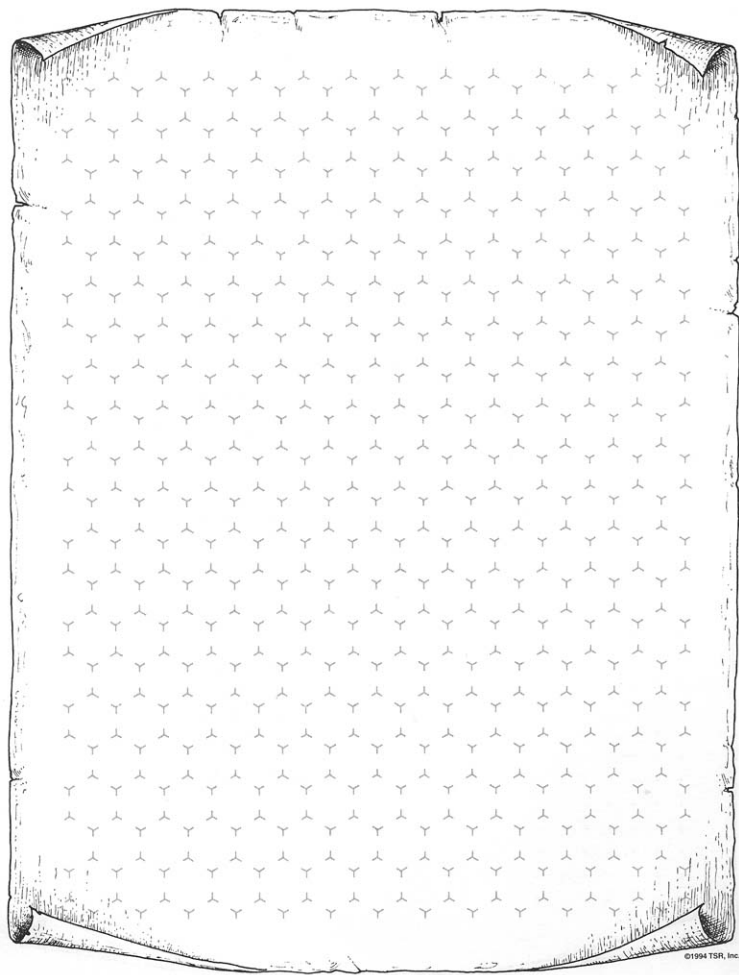

JOIN THE ADVENTURE!

ENTER NEW WORLDS OF EXCITEMENT AND FUN
IN EVERY ISSUE!

Dragon
MAGAZINE

Dungeon
ADVENTURES FOR TSR ROLE-PLAYING GAMES

The leader of the role-playing world offers gaming advice, new ideas, reviews, monsters, cartoons, and treasures not found anywhere else!

The module magazine for AD&D® and D&D® game players leads you to the limits of the known gaming universe!

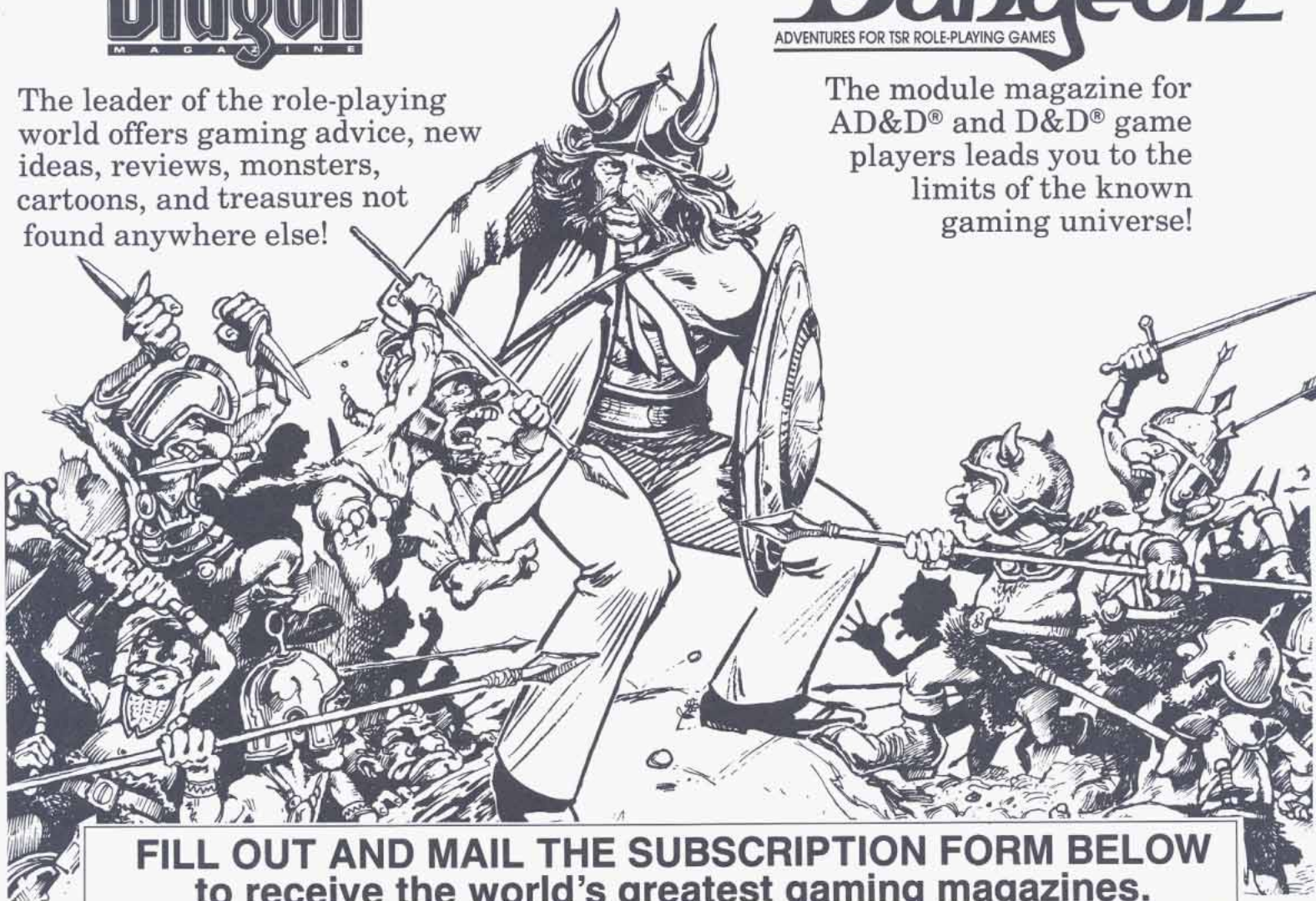

**FILL OUT AND MAIL THE SUBSCRIPTION FORM BELOW
to receive the world's greatest gaming magazines.**

DRAGON® Magazine

Subscription type:

- New Renewal (enclose mailing label)

Amount of payment (send U.S. funds only!)

- | | |
|---|---|
| To U.S. address | To Canadian address |
| <input type="checkbox"/> 1 year (12 issues) for \$30 | <input type="checkbox"/> 1 year (12 issues) for \$36 |
| <input type="checkbox"/> 2 years (24 issues) for \$57 | <input type="checkbox"/> 2 years (24 issues) for \$62 |
| <input type="checkbox"/> 3 years (36 issues) for \$84 | <input type="checkbox"/> 3 years (36 issues) for \$89 |

To foreign address

- 1 year (12 issues), by surface mail, for \$50
 1 year (12 issues), by air mail, for \$90

DUNGEON® Adventures

Subscription type:

- New Renewal (enclose mailing label)

Amount of payment (send U.S. funds only!)

- | | |
|---|---|
| To U.S. address | To Canadian address |
| <input type="checkbox"/> 1 year (6 issues) for \$18 | <input type="checkbox"/> 1 year (6 issues) for \$23 |
| <input type="checkbox"/> 2 years (12 issues) for \$33 | <input type="checkbox"/> 2 years (12 issues) for \$38 |
| <input type="checkbox"/> 3 years (18 issues) for \$48 | <input type="checkbox"/> 3 years (18 issues) for \$53 |

To foreign address

- 1 year (6 issues), by surface mail, for \$35
 1 year (6 issues), by air mail, for \$52

Check the appropriate boxes under the publication(s) to which you are subscribing. Then, mail this form with payments to: TSR, Inc., P.O. Box 5695, Boston MA 02206. (All payments must be in U.S. funds.)

(Please PRINT clearly.)

Name _____

Address _____

City _____ State/Prov. _____

Country _____ Zip/Postal Code _____

Method of Payment

- Check Money order MasterCard VISA

Credit card no. _____

Expiration date _____ MC bank no. _____

Signature _____ Date _____

Your first issue should arrive within 8 to 10 weeks in the U.S. and Canada. All prices are subject to change without notice.

(ASB)

Wizard Abilities by Level

Level	XP	Spells per Day	Weapon Prof.	Nonweapon Prof.	Hit Dice (d4)
1	0	1	1	4	1
2	2,500	2	1	4	2
3	5,000	3	1	4	3
4	10,000	4	1	4	4
5	20,000	4	1	5	5
6	40,000	4	2	6	6
7	60,000	4	2	6	7
8	90,000	4	2	6	8
9	135,000	4	2	7	9
10	250,000	4	2	7	10
11	375,000	4	2	7	10+
12	750,000	4	3	8	10+2
13	1,125,000	5	3	8	10+3
14	1,500,000	5	3	8	10+4
15	2,250,000	5	3	9	10+5
16	2,250,000	5	3	9	10+6
17	2,250,000	5	3	9	10+7
18	3,000,000	5	3	9	10+8
19	3,750,000	5	4	10	10+9
20	3,750,000	5	4	10	10+10

Experience Points; Weapon/Nonweapon Prof.: Weapon/Nonweapon Proficiencies.

Wizard's THAC0 and Saving-Throw Table

Level	1	2	3	4	5	6	7	8	9	10	11	12	13	14	15	16	17	18	19	20
THAC0	20	20	20	19	19	19	18	18	18	17	17	17	16	16	16	15	15	15	14	14
Poison, Paralyzation, Death Magic	14	14	14	14	14	13	13	13	13	13	11	11	11	11	11	10	10	10	10	10
Rod, Staff, Wand	11	11	11	11	11	9	9	9	9	9	7	7	7	7	7	5	5	5	5	5
Petrification, Polymorph*	13	13	13	13	13	11	11	11	11	11	9	9	9	9	9	7	7	7	7	7
Breath Weapon**	15	15	15	15	15	13	13	13	13	13	11	11	11	11	11	9	9	9	9	9
Spell***	12	12	12	12	12	10	10	10	10	10	8	8	8	8	8	4	4	4	4	4

* Excluding polymorph wand attacks.

** Excluding those that cause petrification or polymorph.

*** Excluding those for which another saving-throw type is specified, such as death, petrification, polymorph, etc.

How to Use the Wizard's Screen

This *Wizard's Screen* provides convenient access to tables and lists from the ADVANCED DUNGEONS & DRAGONS® game *Player's Handbook*, *Tome of Magic*, and *Complete Wizard's Handbook*.

The *Wizard's Screen* package contains a screen providing attack numbers (THAC0s) and saving throws for wizard characters in one large-print, combined table. The other side of the screen provides an experience table showing the abilities and powers gained with increasing levels. The screen is assembled by inserting the tabs into the slots as shown in the diagram below. The screen can then fold flat by collapsing the bottom panel for transport to and from your AD&D® game.

Also included are four sheets of reference tables and lists, including a complete list of all wizard spells in the *Player's Handbook* and *Tome of Magic*. Permission is given to photocopy these sheets for personal use only.

ASSEMBLY AND STORAGE DIAGRAM

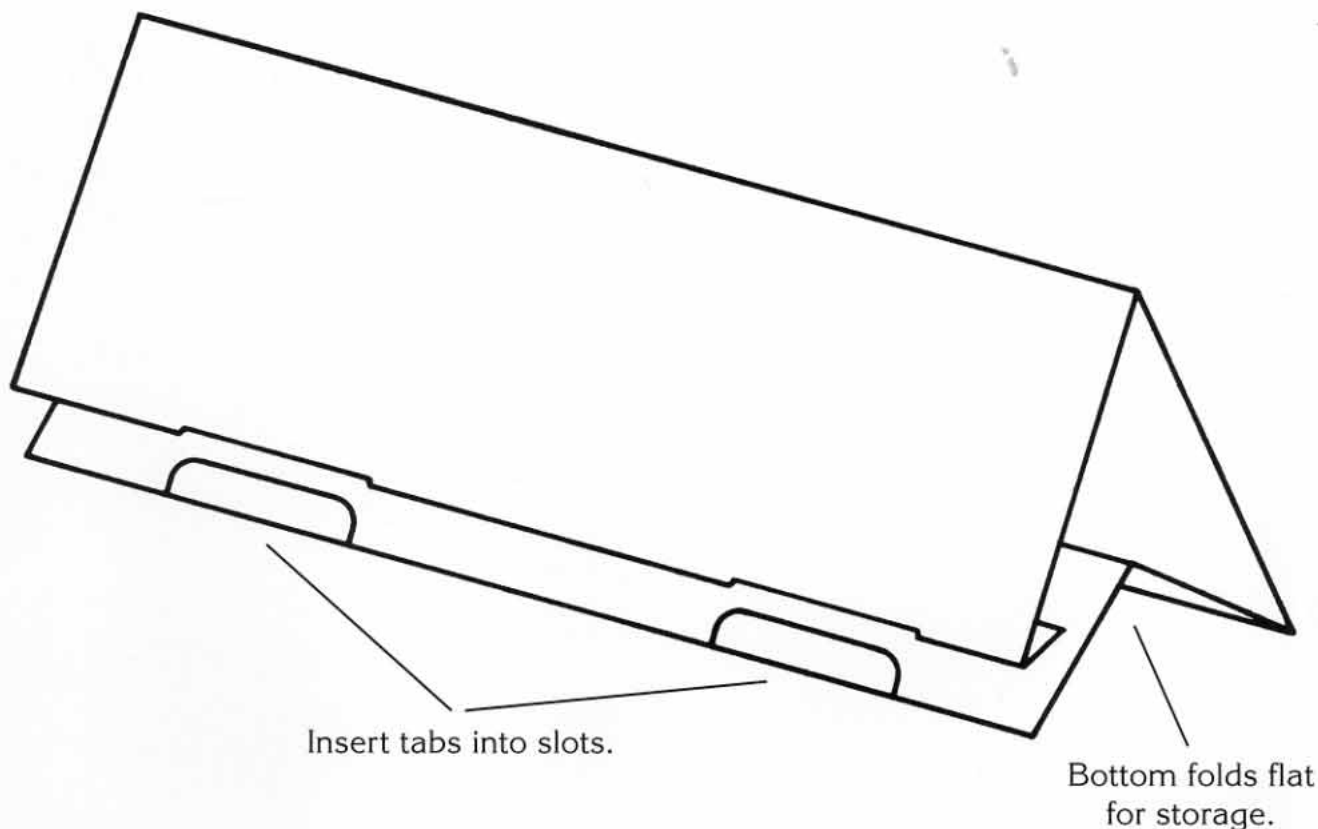

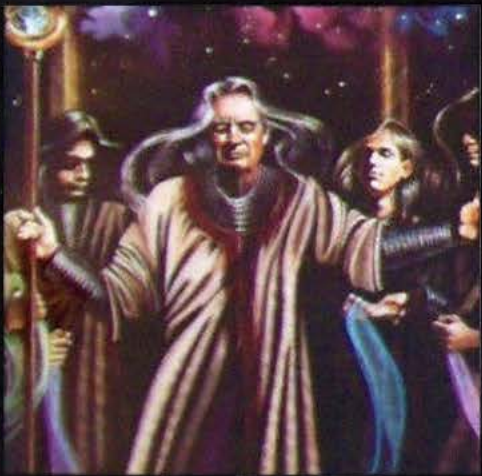

1115XXX4701 ©1994 TSR, Inc. All Rights Reserved.



ELMORE '92

Wizard's Player Pack

You've found the ideal all-in-one playing aid for your favorite game with the AD&D® Game *Wizard's Player Pack*. Inside your *Player Pack* is the information you need to play your chosen class of character—the wizard—with skill and finesse, and a gathering of playing aids selected by TSR game designers as the items both experienced and beginning gamers find most useful. Look at everything you get:

- Game stickers and pencil

- Rugged plastic carrying case

- *Wizard's Screen* providing immediate access to the information from the *Player's Handbook* that you use most frequently while playing your character

- Three 25mm lead-free metal player character miniatures—male and female wizards and an illusionist

- Multicompartment storage tray and lid

- *Wizard Character Record Sheets*

- Eight-page booklet of valuable information about role-playing wizard characters, includes a miniature painting guide

... Plus, room to carry, store, and organize the AD&D rulebooks and other gaming materials you own!

